

Please write clearly in block capitals.

Centre number

--	--	--	--	--

Candidate number

--	--	--	--

Surname

Forename(s)

Candidate signature

I declare this is my own work.

GCSE CHEMISTRY

F

Foundation Tier Paper 1

Friday 17 May 2024

Morning

Time allowed: 1 hour 45 minutes

Materials

For this paper you must have:

- a ruler
- a scientific calculator
- the periodic table (enclosed).

Instructions

- Use black ink or black ball-point pen.
- Pencil should only be used for drawing.
- Fill in the boxes at the top of this page.
- Answer **all** questions in the spaces provided. Do not write outside the box around each page or on blank pages.
- If you need extra space for your answer(s), use the lined pages at the end of this book. Write the question number against your answer(s).
- Do all rough work in this book. Cross through any work you do not want to be marked.

Information

- The maximum mark for this paper is 100.
- The marks for questions are shown in brackets.
- You are expected to use a calculator where appropriate.
- In all calculations, show clearly how you work out your answer.
- You are reminded of the need for good English and clear presentation in your answers.

For Examiner's Use	
Question	Mark
1	
2	
3	
4	
5	
6	
7	
8	
9	
10	
TOTAL	



There are no questions printed on this page

*Do not write
outside the
box*

**DO NOT WRITE ON THIS PAGE
ANSWER IN THE SPACES PROVIDED**



0 1

This question is about elements, compounds and mixtures.

Figure 1 shows diagrams which represent the atoms and molecules in different substances.

Figure 1

● ● and ○ represent different types of atom.

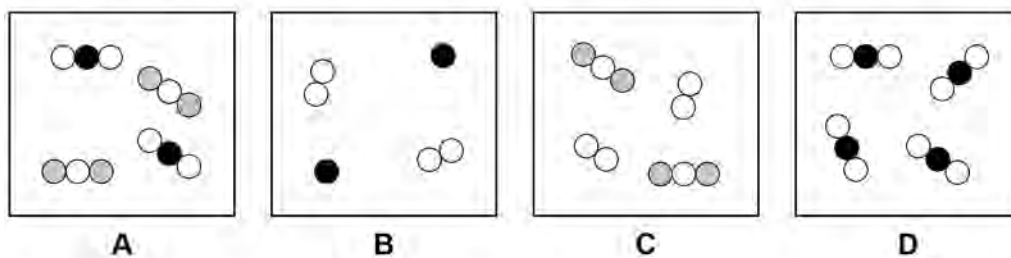

0 1 . 1

Which diagram in **Figure 1** represents a pure compound?

[1 mark]

Tick (✓) **one** box.

A B C D

0 1 . 2

Which diagram in **Figure 1** represents a mixture of an element and a compound?

[1 mark]

Tick (✓) **one** box.

A B C D

Question 1 continues on the next page

Turn over ►



0 1 . 3 Elements are metals or non-metals.

Figure 2 shows an outline of the periodic table.

The periodic table is divided into sections.

Figure 2

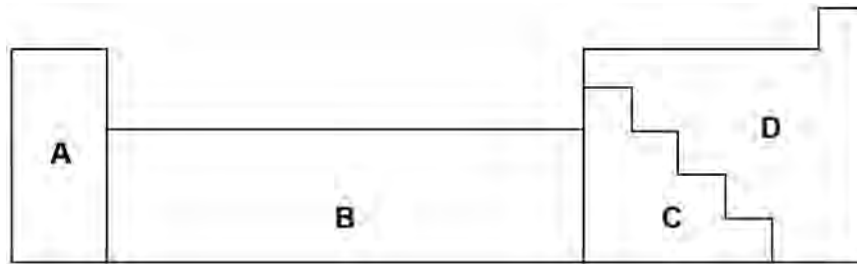

Where are metals found in the periodic table?

[1 mark]

Tick (✓) **one** box.

Section **A** only

Sections **A, B** and **C**

Sections **B, C** and **D**

Section **D** only



0 1 . 4 Which **two** of the following are typical properties of a transition metal?

[2 marks]

Tick (✓) **two** boxes.

Can be bent and shaped

Good conductor of electricity

Low density

Low melting point

Poor conductor of heat

0 1 . 5 Potassium and chlorine react to produce potassium chloride.

An atom of potassium loses an electron to form a potassium ion.

An atom of chlorine gains an electron to form a chloride ion.

Complete the dot and cross diagram.

[2 marks]

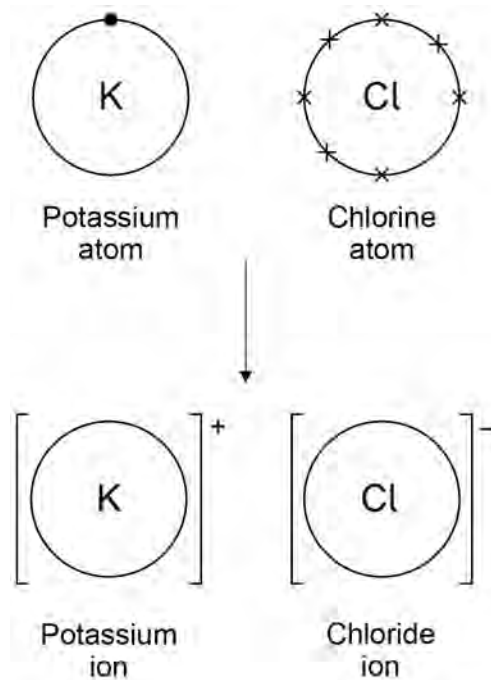

Turn over ►



Mixtures are separated by different methods.

Figure 3 shows the apparatus for separating four different types of mixture.

Figure 3

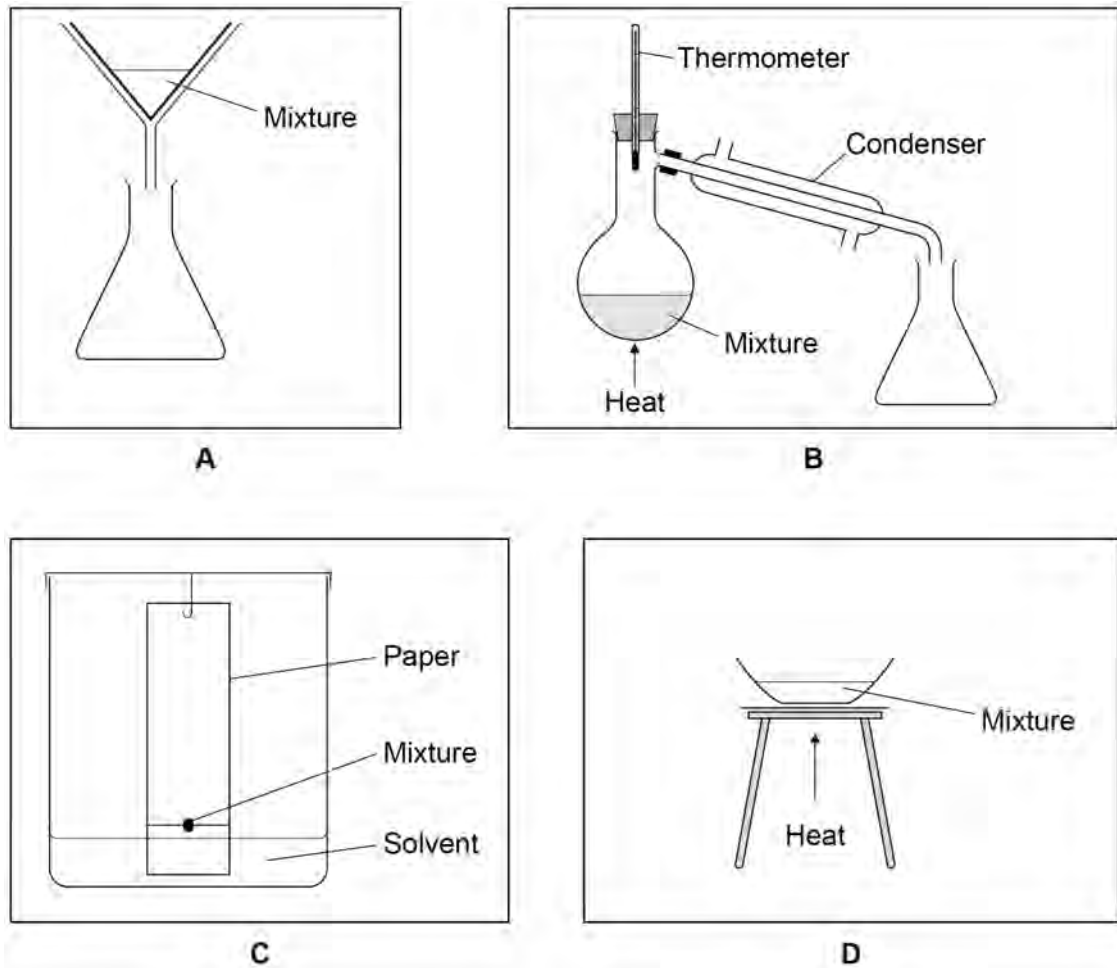

0 1 . 6 Which apparatus could be used to collect water from sodium chloride solution?

Use **Figure 3**.

[1 mark]

Tick (✓) **one** box.

A

B

C

D

0 1 . 7 Which apparatus shows filtration?

Use **Figure 3**.

[1 mark]

Tick (✓) **one** box.

A

B

C

D

9

Turn over for the next question

Turn over ►



0 2

A titration measures the volumes of an acid and an alkali that neutralise each other.

Figure 4 shows the apparatus used.

Figure 4

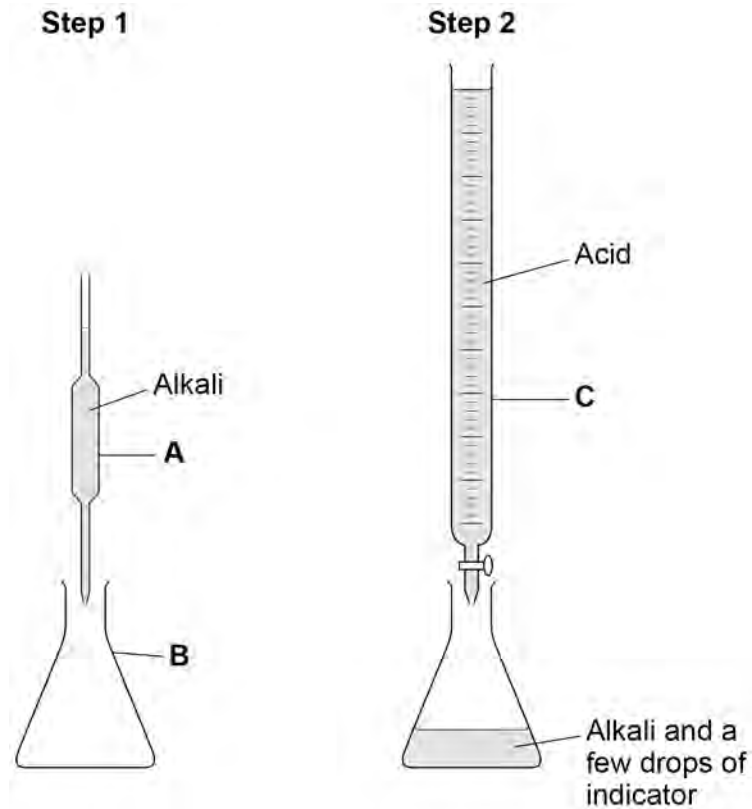

0 2 . 1

Name the pieces of equipment labelled **A**, **B** and **C** in Figure 4.

Choose answers from the box.

[3 marks]

beaker	burette	conical flask
measuring cylinder	pipette	test tube

A _____

B _____

C _____



In **Step 2** in **Figure 4** the acid is added to the alkali until the solution is neutralised.

The volume of acid added is then read from equipment **C**.

0 2 . 2 Name a suitable indicator for use in **Step 2** of the titration.

[1 mark]

0 2 . 3 Give **one** observation that shows the alkali is neutralised.

[1 mark]

0 2 . 4 Give **two** ways to make sure that the volume of acid added is accurate.

[2 marks]

1

2

Question 2 continues on the next page

Turn over ►



0 2 . 5 Figure 5 shows the reading on equipment **C** at the end of **Step 2**.

Figure 5

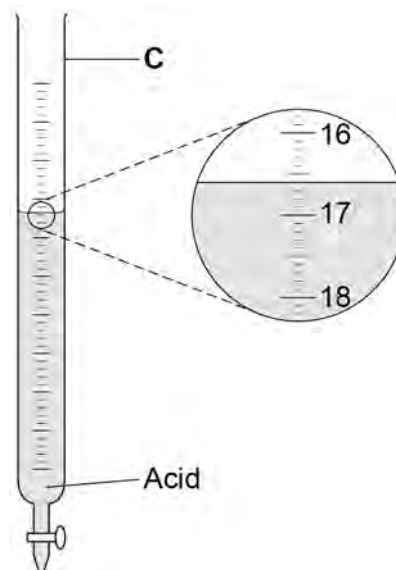

What is the reading on equipment **C** in **Figure 5**?

[1 mark]

Tick (✓) **one** box.

16.4 cm³

16.6 cm³

17.4 cm³

17.6 cm³



0 2 . 6 A student did a different titration.

Table 1 shows the results.

Table 1

	Trial 1	Trial 2	Trial 3
Volume of acid added in cm³	25.3	23.7	23.6

Which **two** results should be used to calculate the mean volume of acid added?

[1 mark]

Tick (✓) **one** box.

Trial 1 and Trial 2

Trial 1 and Trial 3

Trial 2 and Trial 3

0 2 . 7 A salt is produced when an acid neutralises an alkali.

Barium chloride is a salt containing the ions Ba²⁺ and Cl⁻

What is the formula of barium chloride?

[1 mark]

Tick (✓) **one** box.

BaCl

BaCl₂

Ba₂Cl

Ba₂Cl₂

10

Turn over for the next question

Turn over ►



0 3

This question is about energy changes of reactions.

Zinc reacts with copper sulfate solution.

The word equation for the reaction is:

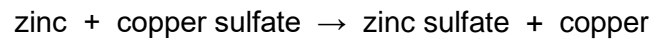
**0 3 . 1**

What type of reaction is the reaction between zinc and copper sulfate solution?

[1 mark]

Tick (✓) **one** box.

Combustion

Decomposition

Displacement

0 3 . 2

Calculate the percentage (%) by mass of copper in copper sulfate (CuSO_4).

Give your answer to 3 significant figures.

Relative atomic mass (A_r): Cu = 63.5

Relative formula mass (M_r): $\text{CuSO}_4 = 159.5$

[3 marks]

Percentage by mass (3 significant figures) = _____ %



A student investigated the energy change in the reaction between zinc and copper sulfate solution.

This is the method used.

1. Measure 25 cm³ of copper sulfate solution into a polystyrene cup.
2. Weigh 0.20 g of zinc powder.
3. Add the zinc powder to the copper sulfate solution.
4. Measure the highest temperature reached by the mixture.
5. Repeat steps 1 to 4 using different masses of zinc powder.

0 3 . 3

Control variables are used to make an investigation a fair test.

Which is a control variable in the investigation?

[1 mark]

Tick (✓) **one** box.

Highest temperature reached by the mixture

Mass of zinc powder

Volume of copper sulfate solution

Question 3 continues on the next page

Turn over ►



Figure 6 shows the results.

Figure 6

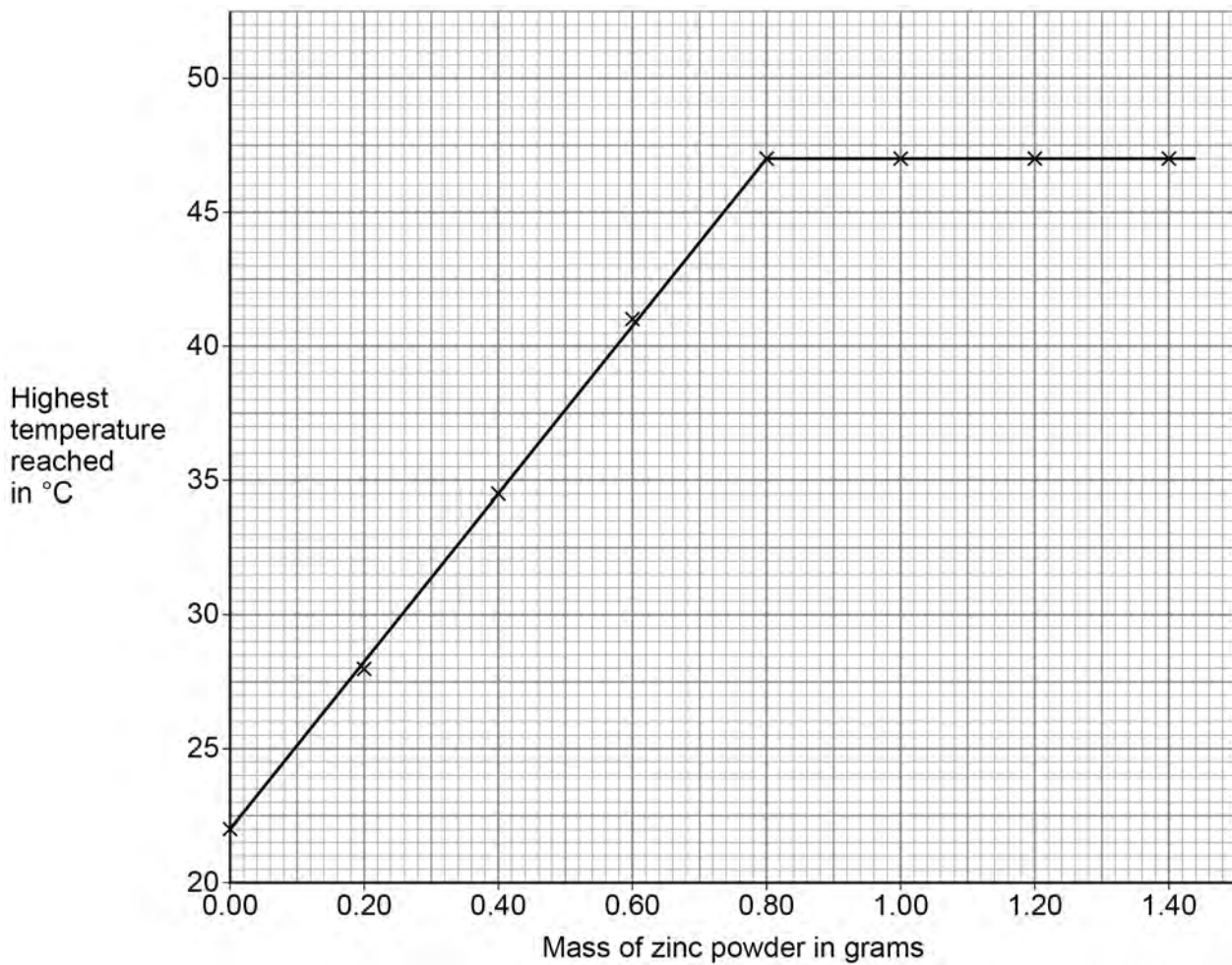

0 3 . 4

What is the minimum mass of zinc powder needed to react with all the copper sulfate solution?

Use Figure 6.

[1 mark]

Minimum mass of zinc powder = _____ g



0 3 . 5

What is the maximum temperature change in the reaction between zinc powder and 25 cm³ of copper sulfate solution?

Use **Figure 6**.

[2 marks]

Maximum temperature change = _____ °C

0 3 . 6

25 cm³ of copper sulfate solution contained 6.75 g of copper sulfate.

Calculate the concentration of the solution in g/dm³.

You should:

- calculate the volume of the solution in dm³ (1000 cm³ = 1 dm³)
- use the equation:

$$\text{concentration of solution in g/dm}^3 = \frac{\text{mass of copper sulfate in grams}}{\text{volume of solution in dm}^3}$$

[3 marks]

Volume of solution = _____ dm³

Concentration of solution = _____ g/dm³

Question 3 continues on the next page

Turn over ►



Another student investigated the energy change of the reaction between sodium hydrogencarbonate and hydrochloric acid.

This is the method used.

1. Measure 25 cm³ of hydrochloric acid.
2. Weigh 1.0 g of sodium hydrogencarbonate.
3. Add the sample of sodium hydrogencarbonate to the hydrochloric acid.
4. Measure the lowest temperature reached by the mixture.
5. Repeat steps 1 to 4 using different masses of sodium hydrogencarbonate.

Figure 7 shows the results.

Figure 7

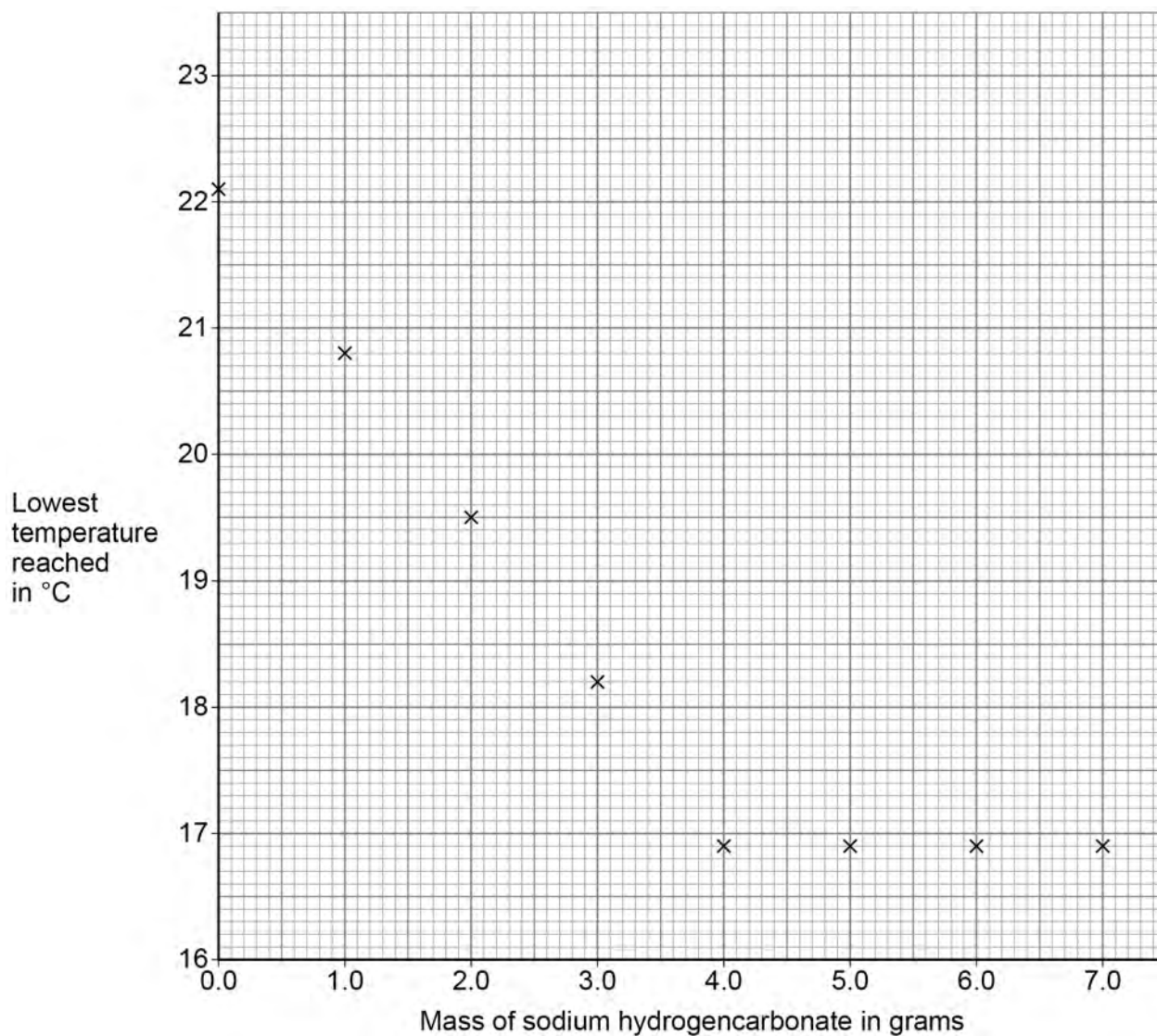

0 3 . 7 Draw **two** straight lines of best fit on **Figure 7**.

The lines should cross.

[2 marks]

0 3 . 8 Which statement describes the energy change in the reaction shown in **Figure 7**?

[1 mark]

Tick (✓) **one** box.

Energy is **transferred to** the surroundings so the reaction is **endothermic**.

Energy is **transferred to** the surroundings so the reaction is **exothermic**.

Energy is **taken in from** the surroundings so the reaction is **endothermic**.

Energy is **taken in from** the surroundings so the reaction is **exothermic**.

14

Turn over for the next question

Turn over ►



There are no questions printed on this page

*Do not write
outside the
box*

**DO NOT WRITE ON THIS PAGE
ANSWER IN THE SPACES PROVIDED**



0 4

This question is about small particles.

0 4 . 1

What is the approximate number of atoms in a nanoparticle?

[1 mark]Tick (✓) **one** box.

A few hundred atoms

A few thousand atoms

A few million atoms

A few billion atoms

0 4 . 2

Nanoparticles of some elements can be used as catalysts.

Which element is most likely to be used as a catalyst?

Use the periodic table.

[1 mark]Tick (✓) **one** box.

Aluminium

Iron

Magnesium

Question 4 continues on the next page**Turn over ►**

0 4 . 3 Nanoparticles are used in sun creams and in wound dressings.

A wound dressing is placed next to the skin to prevent infection.

Figure 8 shows a wound dressing.

Figure 8



Table 2 shows some information about substances used in the form of nanoparticles.

Table 2

Substance	Property
Carbon	Strong
Silicon dioxide	Hard
Silver	Kills bacteria
Titanium dioxide	Blocks light



Draw **one** line from each use to the best substance for that use.

[2 marks]

Use

Substance

Sun creams

Carbon

Silicon dioxide

Wound dressings

Silver

Titanium dioxide

Question 4 continues on the next page

Turn over ►



0 4 . 4 Figure 9 shows a cubic nanoparticle.

Figure 9

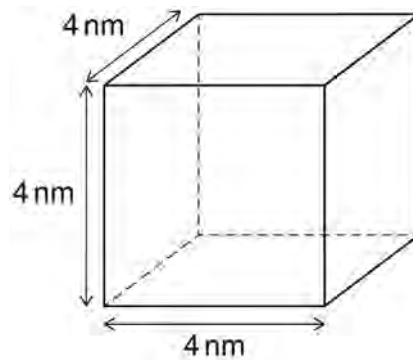

Calculate:

- the surface area of the cubic nanoparticle
- the volume of the cubic nanoparticle
- the simplest whole number ratio of surface area : volume for the cubic nanoparticle.

Use the equation:

surface area of cubic nanoparticle = $6 \times$ surface area of one face

[6 marks]

Surface area of cubic nanoparticle = _____ nm^2

Volume of cubic nanoparticle = _____ nm^3

Simplest whole number ratio of surface area: volume = _____ : _____

10



0 5

This question is about carbon and carbon compounds.

An atom of carbon is represented as:

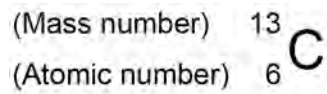
**0 5 . 1**

What is the number of protons in this atom of carbon?

Tick (✓) **one** box.**[1 mark]**1 6 7 13 **0 5 . 2**

What is the number of neutrons in this atom of carbon?

Tick (✓) **one** box.**[1 mark]**1 6 7 13 **0 5 . 3**

What is the number of electrons in this atom of carbon?

Tick (✓) **one** box.**[1 mark]**1 6 7 13 **Question 5 continues on the next page****Turn over ►**

0 5 . 4 Figure 10 shows the structure of a carbon compound.

Figure 10

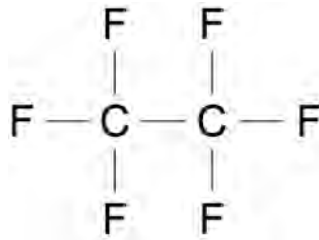

Complete the formula of the carbon compound.

[1 mark]

C _ F _

0 5 . 5 Methane:

- is a carbon compound
- exists as small molecules
- has a low boiling point.

What is the reason for the low boiling point of methane?

[1 mark]

Tick (✓) **one** box.

Covalent bonds **and** intermolecular forces are weak.

Only covalent bonds are weak.

Only intermolecular forces are weak.



0 5 . 6 Buckminsterfullerene (C_{60}) is a form of carbon.

Buckminsterfullerene was the first fullerene to be discovered.

What is the shape of a buckminsterfullerene molecule?

[1 mark]

Tick (✓) **one** box.

Cubic

Cylindrical

Spherical

Question 5 continues on the next page

Turn over ►



0 5 . 7 Graphite is a form of carbon.

Figure 11 represents the structure of graphite.

Figure 11

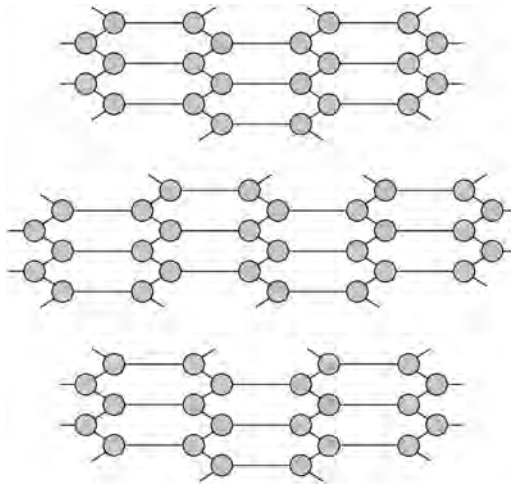

Key

● = carbon atom

How many covalent bonds does each carbon atom form in graphite?

[1 mark]

Tick (✓) **one** box.

1

2

3

4



0 5 . 8 Diamond is another form of carbon.

Figure 12 represents the structure of diamond.

Figure 12

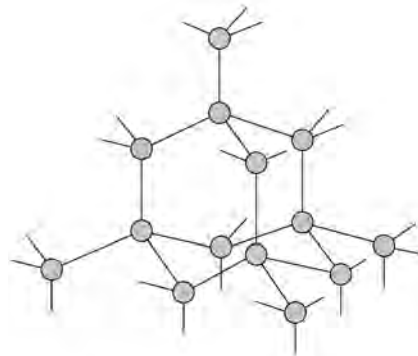

Key

● = carbon atom

Describe the structure and bonding in diamond.

[3 marks]

10

Turn over for the next question

Turn over ►



0 6

This question is about electrolysis and the extraction of metals.

0 6 . 1

Why can some molten substances be electrolysed?

[1 mark]

Tick (✓) **one** box.

Electrons can move through the molten substance to the electrodes.

Ions can move through the molten substance to the electrodes.

Protons can move through the molten substance to the electrodes.

0 6 . 2

Table 3 shows the products of the electrolysis of some molten compounds.

Complete **Table 3**.

[3 marks]

Table 3

Molten compound	Product at negative electrode	Product at positive electrode
Lead chloride	_____	Chlorine
Potassium iodide	Potassium	_____
_____	Zinc	Bromine



Aluminium is extracted by electrolysis of molten aluminium oxide.

0 6 . 3 Balance the equation for the reaction.

Choose numbers from the box.

[2 marks]

2	3	4	5
---	---	---	---



0 6 . 4 Calculate the relative formula mass (M_r) of aluminium oxide (Al_2O_3).

Relative atomic masses (A_r): O = 16 Al = 27

[2 marks]

Relative formula mass (M_r) = _____

Question 6 continues on the next page

Turn over ►



0 6 . 5 **Figure 13** shows part of the reactivity series of metals.

The non-metal carbon has been included.

Figure 13

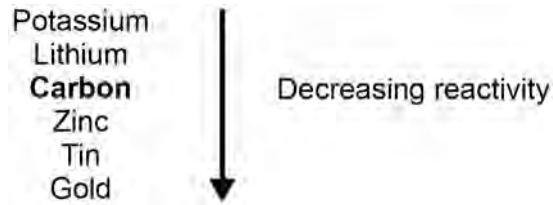

Metals can be extracted from their compounds by:

- electrolysis
- reduction with carbon.

Electrolysis is more expensive than reduction with carbon.

Predict one metal that would be extracted by each method.

Use Figure 13.

[2 marks]

Extracted by electrolysis _____

Extracted by carbon reduction _____

10



Turn over for the next question

*Do not write
outside the
box*

**DO NOT WRITE ON THIS PAGE
ANSWER IN THE SPACES PROVIDED**

Turn over ►



0 7

This question is about chemical cells.

0 7 . 1

A student connects four 1.5 V cells in series to make a battery.

What is the total voltage produced by the battery?

[1 mark]

Voltage = _____ V

A chemical cell can be made using two different metals in contact with an electrolyte.

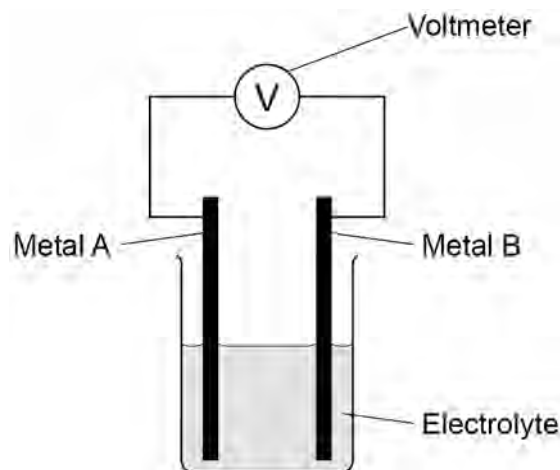
Figure 14 shows a chemical cell.**Figure 14**

0 7 . 2

Which is a suitable electrolyte for a chemical cell?

[1 mark]Tick (✓) **one** box.

Pure water

Solid lead bromide

Sodium chloride solution



0 8

A student produced a salt by reacting copper carbonate with sulfuric acid.

This is the method used.

1. Measure 50 cm³ of sulfuric acid into a beaker.
2. Add copper carbonate powder.
3. Stir the mixture.
4. Repeat steps 2 and 3 until copper carbonate is in excess.
5. Filter the mixture.
6. Warm the filtrate gently until crystals start to appear.
7. Leave the solution to cool and crystallise.

0 8 . 1

Complete the word equation for the reaction.

[2 marks]

copper carbonate + sulfuric acid → _____ + _____ + carbon dioxide

0 8 . 2

Give **one** observation the student could make during **Step 4** which shows that the copper carbonate is in excess.

[1 mark]

0 8 . 3

Give **one** reason for filtering the mixture in **Step 5**.

[1 mark]



0 8 . 4

Name the equipment that can be used to warm the filtrate **gently** in **Step 6**.

[1 mark]

0 8 . 5

The maximum theoretical mass of the salt that could be produced using 50 cm³ of the sulfuric acid is 12.5 g.

The percentage yield of the salt is 92.8%.

Calculate the mass of salt actually produced.

Use the equation:

$$\% \text{ yield} = \frac{\text{mass of salt actually produced}}{\text{maximum theoretical mass of salt that could be produced}} \times 100$$

[3 marks]

Mass of salt actually produced = _____ g

Question 8 continues on the next page**Turn over ►**

0 8 . 6

Some salts can be produced by reacting sulfuric acid with a metal.

Neither copper nor sodium is used to produce a salt with sulfuric acid.

Give **one** reason why each metal is **not** used.

[2 marks]

Copper _____

Sodium _____

10



0 9

This question is about the periodic table.

Sodium and potassium are in Group 1 of the periodic table.

0 9 . 1

Give **one** similarity and **one** difference between the electronic structures of sodium and potassium.

[2 marks]

Similarity _____

Difference _____

Group 1 elements react with water.

0 9 . 2

Give **two** observations made when potassium reacts with water.

[2 marks]

1 _____

2 _____

0 9 . 3

Potassium hydroxide solution is produced when potassium reacts with water.

What is the colour of universal indicator when added to potassium hydroxide solution?

Give **one** reason for your answer.

[2 marks]

Colour of universal indicator _____

Reason _____

Turn over ►

Table 4 shows the densities of some of the elements in Group 0 of the periodic table.

Table 4

Element	Atomic number	Density in mg/cm^3
Helium	2	0.2
Neon	10	0.8
Argon	18	1.6
Krypton	36	X
Xenon	54	5.4
Radon	86	9.1

0 9 . 4 Plot the data from **Table 4** on **Figure 15**.

[2 marks]

Figure 15

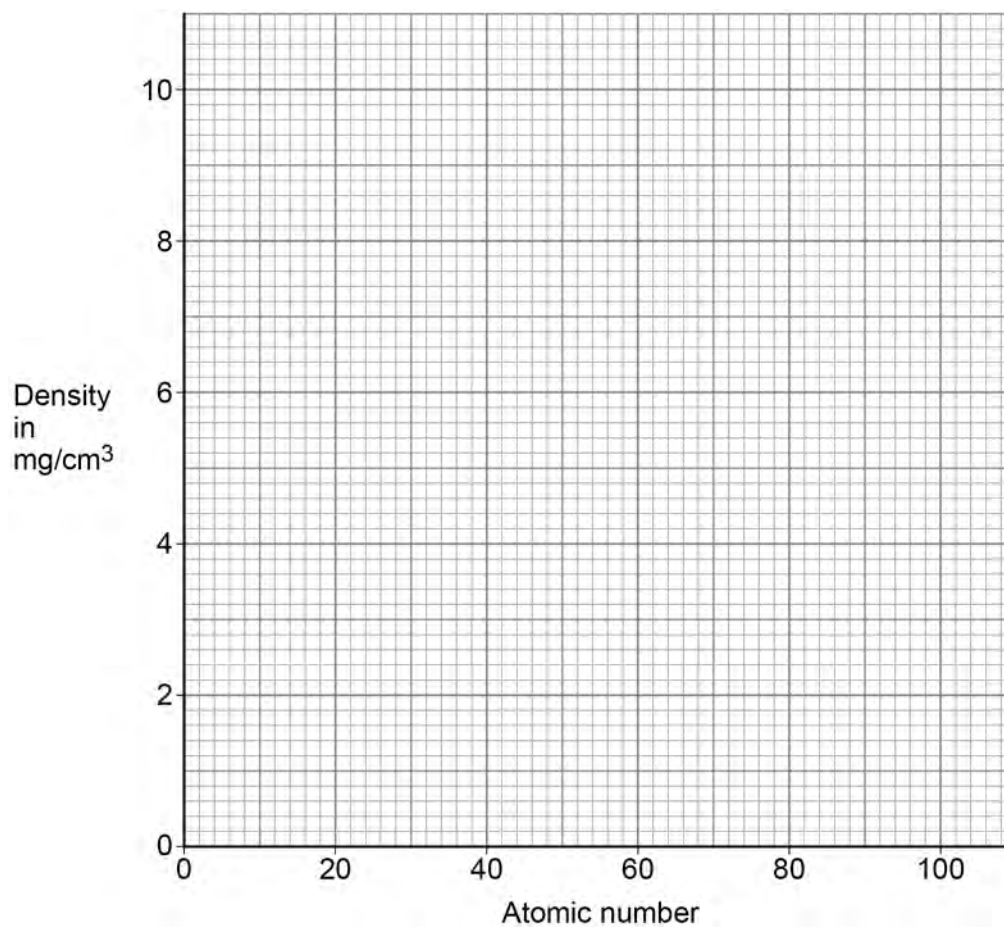

0 9 . 5 Estimate the density (**X**) of krypton.

Use **Figure 15** and **Table 4**.

[1 mark]

Density = _____ mg/cm³

0 9 . 6 The elements in Group 7 are called the halogens.

A more reactive halogen can displace a less reactive halogen from a solution of its salt.

Which combination of solutions will produce a reaction when mixed?

[1 mark]

Tick (✓) **one** box.

Chlorine and potassium fluoride

Chlorine and potassium bromide

Bromine and potassium fluoride

Bromine and potassium chloride

0 9 . 7 Which of the following describes the trends going down Group 7?

[1 mark]

Tick (✓) **one** box.

Relative molecular mass decreases and boiling point decreases.

Relative molecular mass decreases and boiling point increases.

Relative molecular mass increases and boiling point decreases.

Relative molecular mass increases and boiling point increases.

11

Turn over ►



1 0

This question is about models of the atom.

Figure 16 shows two early models of the atom.

Figure 16

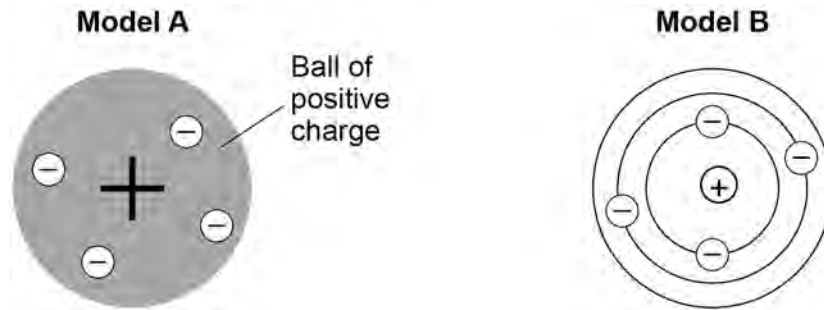

1 0 . 1

Name the models of the atom shown in **Figure 16**.

[2 marks]

Model A _____

Model B _____

1 0 . 2

Compare model A with the model of the atom used today.

Use **Figure 16**.

[4 marks]



1 0 . 3 Chadwick's experiments showed the existence of neutrons in an atom.

This led to an understanding of isotopes.

Define the term 'isotopes'.

Refer to subatomic particles in your answer.

[2 marks]

8

END OF QUESTIONS



There are no questions printed on this page

*Do not write
outside the
box*

**DO NOT WRITE ON THIS PAGE
ANSWER IN THE SPACES PROVIDED**



